

High Power Lightning Arrestor with 7/16 DIN Connectors and Replaceable Protective Elements

Features:

- ✦ 40kA+ Surge Protection
- ✦ Passes DC Current
- ✦ Frequency to 1000MHz
- ✦ Excellent RF Performance
- ✦ Multiple Strike Capability
- ✦ Bi-directional Protection
- ✦ Rugged and Waterproof



PTR7AF7AF14K1 Shown

RF Specifications

Frequency (MHz)	VSWR	Insertion Loss (dB)
dc – 500	1.20 Max	0.10 Max
512 – 1000	1.30 Max	0.20 Max

- ✦ Nominal Impedance – 50Ω
- ✦ Through Voltage: +/-48Vdc
- ✦ RF Power: See Protection Voltage table
- ✦ Intermod Reduced

Transient Specifications

(1.2X50μs Voltage / 8X20μs Current waveform)

- ✦ Maximum Transient: 40kA+
- ✦ Multiple Strike: 30kA 10x / 20kA 20x
- ✦ Let-through: See Protection Voltage table
- ✦ Replaceable Gas Discharge Tubes 1400V to 3500V

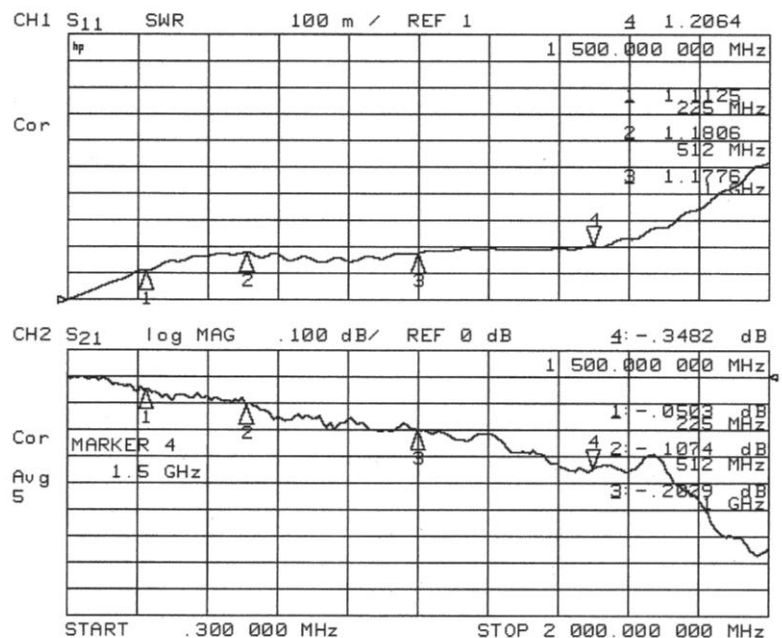

Typical VSWR and Insertion Loss

Mechanical Specifications

Weight: 1.2 pounds / 544g typical

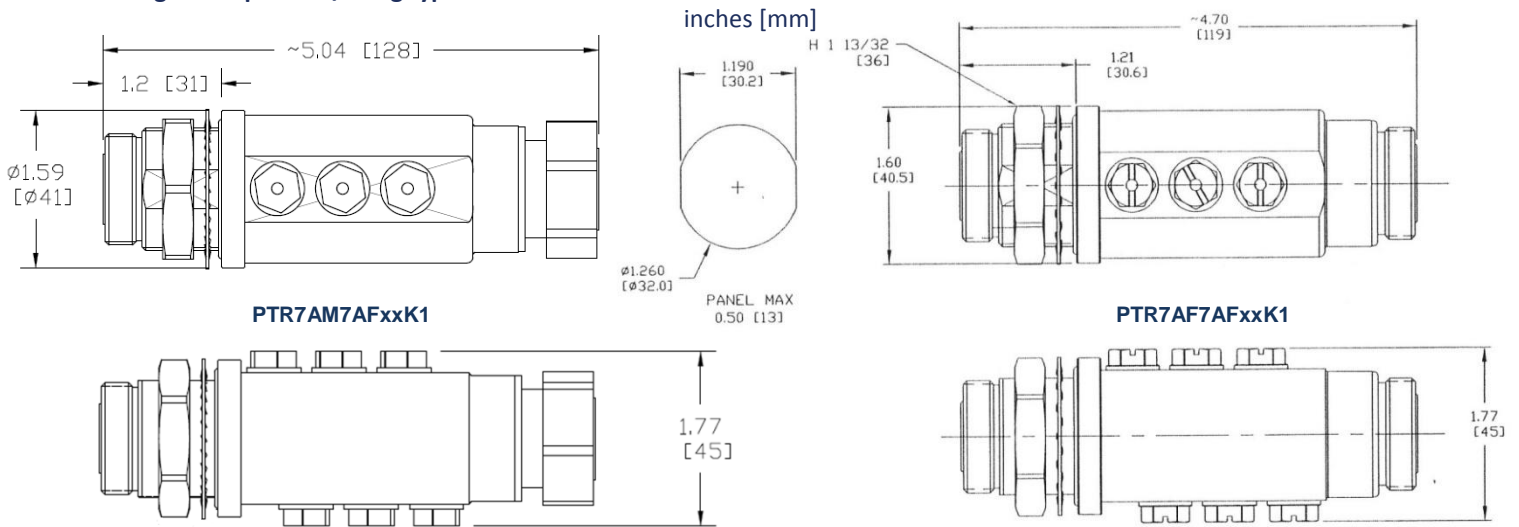

Material and Finish

Component	Material	Finish
Outer Parts	Brass	GuardPlate™
Center Contact	BeCu	Silver
Insulator	PTFE	-
Gasket	Si Rubber	-

Guardplate™ is an alloy finish with the PIM and conductivity of Silver and the durability and anti-tarnish properties of Nickel.

Protection Voltage

Protection Voltage ¹	Voltage Code ²	Max RF Power ³		Let-through ⁴ kV _{pk} / mJ
		kW _{cw}	kW _{peak}	
1400	14	8	14	2.0 / 35
2500	25	20	45	3.8 / 125
3500	35	50	88	4.6 / 200

¹ For multiple carriers, sum of peak voltages should not exceed 60% of the protection voltage

² Use the voltage code in the part number

³ By GDT Voltage Alone: At Sea Level, VSWR = 1.0, At Low Freq.

⁴ Input is 6kV@1.2x50µs / 3kA@8x20µs.

- Rating guidelines are provided to estimate product performance – attached cables & connectors, mounting method & air flow can affect performance. Due to high power levels, qualification testing is highly recommended.
- Do not service unit while RF power is present
- For safety, gas discharge tube (GDT) access nuts must remain tightened while transmission lines are active.

Environmental Specifications

Temperature Range	-40°C to +90°C
Salt Fog	MIL-STD-202 Method 101D / Condition A (35°C/96 hrs)
Immersion	MIL-STD-202 Method 104A / Condition A (65°C to 25°C w/NaCl – 2 cycles)
Moisture Resistance	MIL-STD-202 Method 106E (65°C/98% RH condensing/240 hrs)
Temperature Shock	MIL-STD-202 Method 107D / Condition B-1 (25 cycles -65°C to +125°C)
Life (Elevated Temperature)	MIL-STD-202 Method 108A / Condition A (96 hours at 100°C)
Dust and Waterproof Rating	IEC529 IP68 (dust-tight and water proof 24 hrs / 1 m)
Vibration	MIL-STD-202 Method 204D / Condition D (10Hz-2kHz 0.06"DA/20g)
Mechanical Shock	MIL-STD-202 Method 213 / Condition A (50g/11ms ~24")

Thermal RF Power Rating
(VSWR=1.0, 25°C, Sea Level)

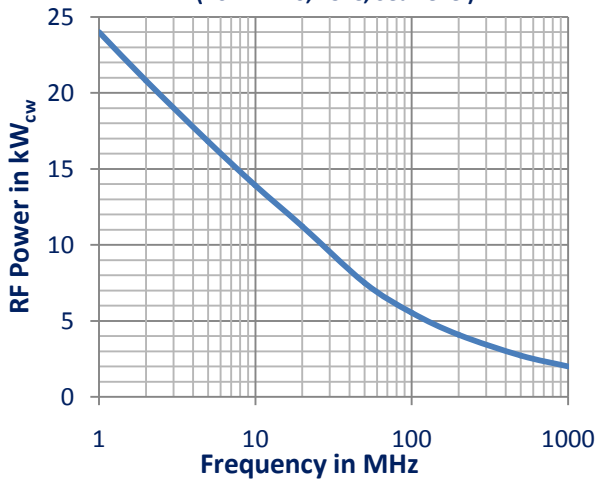

Voltage / Altitude Rating
(VSWR = 1.0, 25°C)

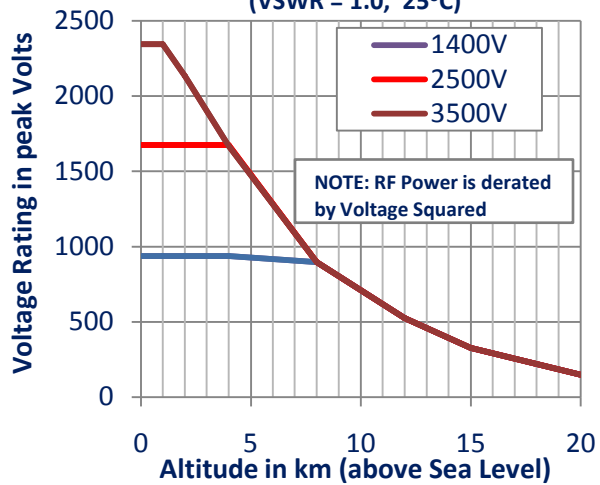

Power Altitude Thermal Derating

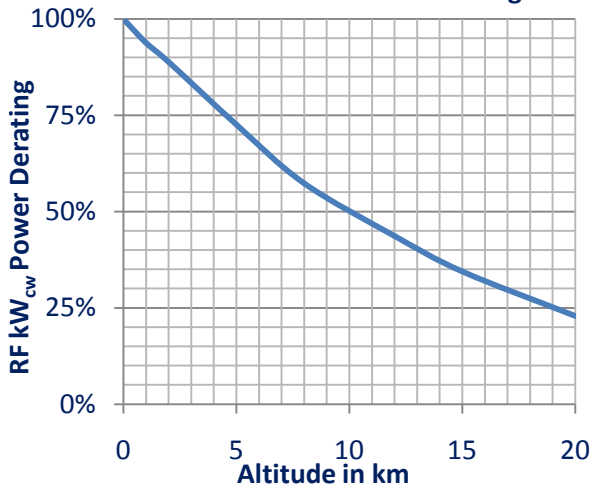

VSWR RF Voltage and Power Derating

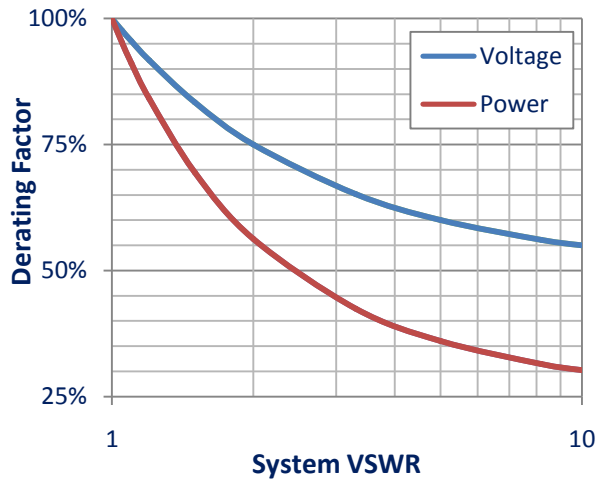

Temperature Power Thermal Derating

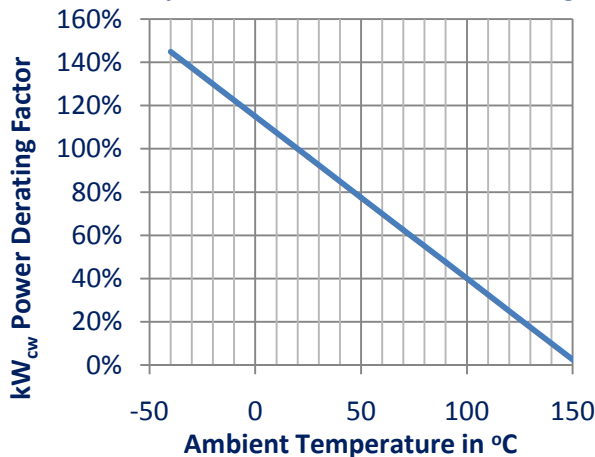

Part Number

PTR 7Ax7AF xx K1

- K1 specifies the model type
- Voltage Code - select based on the RF power. Use the *Protection Voltage* table on page 2
- Connector Codes – 7AF7AF for female to female, 7AM7AF for male to female
- PTR Family - (Protector w/ replaceable Gas Discharge Tubes)